

0.3mm Contact Pitch, 1.25mm above the board, Flexible Printed Circuit Connectors

FH 23 Series

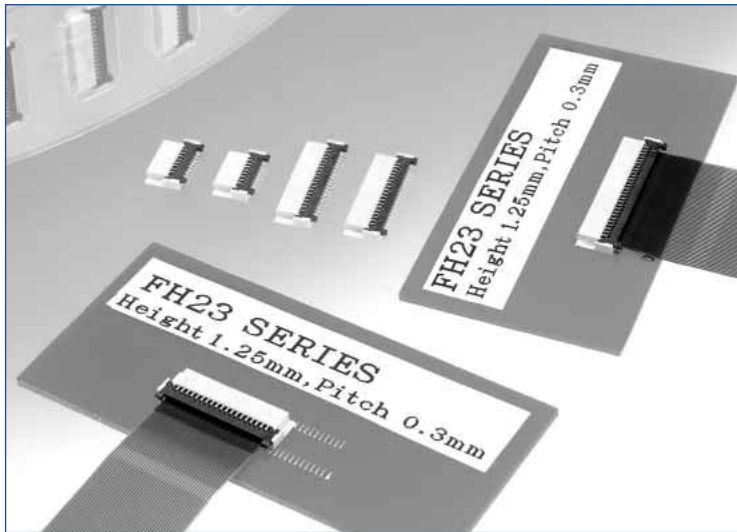

● Staggered termination configuration. Only 1.25 mm above the board.

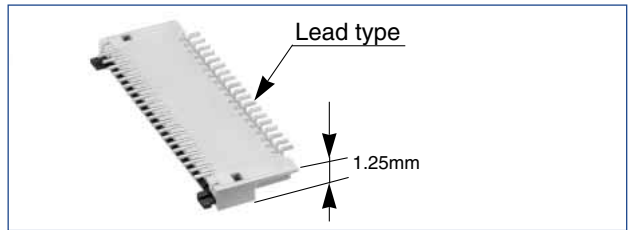
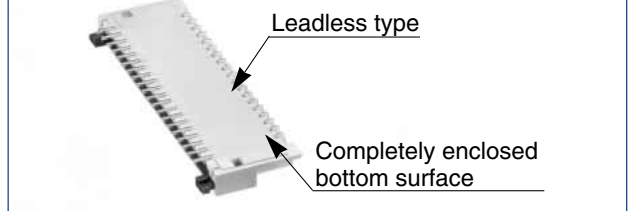

Features

1. FPC low insertion force and high holding force

Hirose Electric's unique low insertion force (LIF) design (patents pending) improves the Flexible Printed Circuit (FPC) holding force after insertion.

FPC insertion force: Reduced approximately 36% (as compared with FH18 Series connectors).

FPC holding force: Improvement of approximately 22% (as compared with FH18 Series connectors).

2. Temporary hold of FPC

There is no need to hold the FPC after insertion in the connector. The connector will hold it in correct position, allowing closing of the actuator.

3. Easy board mounting

The surface mounted termination of the contacts is staggered on 0.6 mm centers, positioned on front and back of the connector. Bottom of the connector is completely insulated, allowing conductive traces on PCB to run under the connector.

4. Proven Flip-lock Actuator assures easy and reliable operation

Rotating actuator permits easy insertion and reliable connection with the FPC. Tactile sensation confirms complete mechanical locking of the actuator and the electrical connection.

5. Variations to suit different mounting areas

Available with lead and leadless type of terminations (for opposing FPC insertion side).

6. Designed for placement with automatic equipment

Flat top surface allows pick-up with vacuum nozzles. Packaged in embossed tape, on reel. One reel contains 2,500 pieces.

7. Accepts 0.2mm thick FPC

8. Variety of contact positions

Available with 15, 17, 21, 23, 25, 27, 31, 33, 37, 39, 45, 51, 61 and 71 pos.

Applications

Mobile phones, PDA's, digital cameras, digital video cameras and other compact devices requiring interconnections of the main circuit with the LCD, plasma display (PDP), camera module, or other devices.

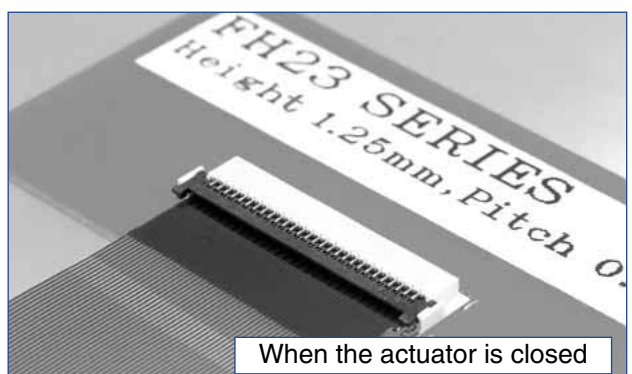
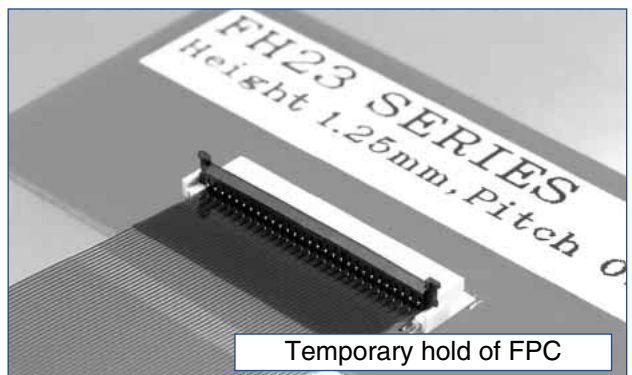
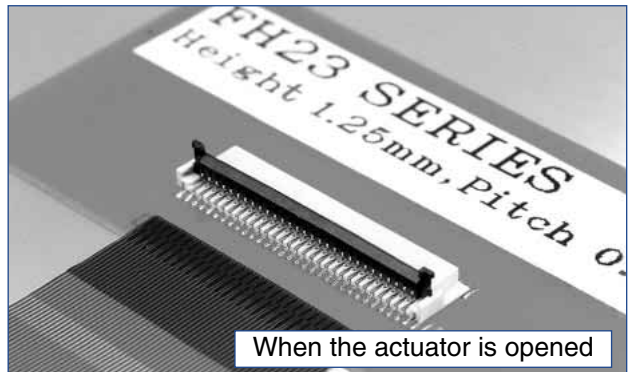

FH23 Series 0.3mm Contact Pitch, 1.25mm above the board, Flexible Printed Circuit Connectors

Product Specifications

Ratings	Current rating 0.3A	Operating temperature range -55 °C to +85°C (Note 1)	Storage temperature range -10°C to +50°C (Note 2)
	Voltage rating 30V AC	Operating humidity range Relative humidity 90% max. (No condensation)	Storage humidity range Relative humidity 90% max. (No condensation)

Recommended FPC	Thickness: = 0.2±0.03mm Gold plated
-----------------	-------------------------------------

Item	Specification	Conditions
1. Insulation resistance	50 M ohms min.	100 V DC
2. Withstanding voltage	No flashover or insulation breakdown	90 V AC/one minute
3. Contact resistance	100 m ohms max. *Including FPC/FFC conductor resistance	1 mA AC
4. Durability (insertion / withdrawal)	Contact resistance: 100 m ohms max. No damage, cracks, or parts dislocation.	10 cycles
5. Vibration	No electrical discontinuity of 1 μs or more. Contact resistance: 100 m ohms max. No damage, cracks, or parts dislocation.	Frequency: 10 to 55 Hz, single amplitude of 0.75 mm, 10 cycles, 3 axis.
6. Shock	No electrical discontinuity of 1 μs or more. Contact resistance: 100 m ohms max. No damage, cracks, or parts dislocation.	Acceleration of 981 m/s ² , 6ms duration, sine half-wave waveform, 3 cycles, 3 axis.
7. Humidity (Steady state)	Contact resistance: 100 m ohms max. Insulation resistance: 50 M ohms min. No damage, cracks, or parts dislocation.	96 hours at 40°C and humidity of 90% to 95%
8. Temperature cycle	Contact resistance: 100 m ohms max. Insulation resistance: 50 M ohms min. No damage, cracks, or parts dislocation.	Temperature: -55°C → +15°C to +35°C → +85°C → +15°C to +35°C Time: 30 → 2 to 3 → 30 → 2 to 3 (Minutes) 5 cycles
9. Resistance to soldering heat	No deformation of components affecting performance.	Reflow: At the recommended temperature profile Manual soldering: 350 °C ± 5 °C for 5 seconds

Note 1: Includes temperature rise caused by current flow.

Note 2: The term "storage" refers to products stored for long period of time prior to mounting and use. Operating Temperature Range and Humidity range covers non-conducting condition of installed connectors in storage, shipment or during transportation.

Materials

Part	Material	Finish	Remarks
Insulator	LCP	Color: Beige	UL94V-0
Actuator	LCP	Color: Black	
Contacts	Phosphor bronze	Gold plated	_____

Ordering information

FH23 - 39S - 0.3 SHW (05)

① ② ③ ④ ⑤

<p>① Series name : FH23</p> <p>② No. of contacts. Number of contacts : 15,17,21,23,25,27,31,33,37,39,45,51,61,71</p> <p>③ Contact pitch: 0.3mm</p> <p>④ Terminal type SHW: SMT horizontal mounting type, lead type termination. SHAW: SMT horizontal mounting type, lead-less type termination.</p>	<p>⑤ Plating specifications :</p> <p>(05) : Gold flash plated (All contact positions except 51 contacts)</p> <p>(06) : Gold flash plated (51 contacts)</p>
---	--

Connector Dimensions (Lead Type termination)

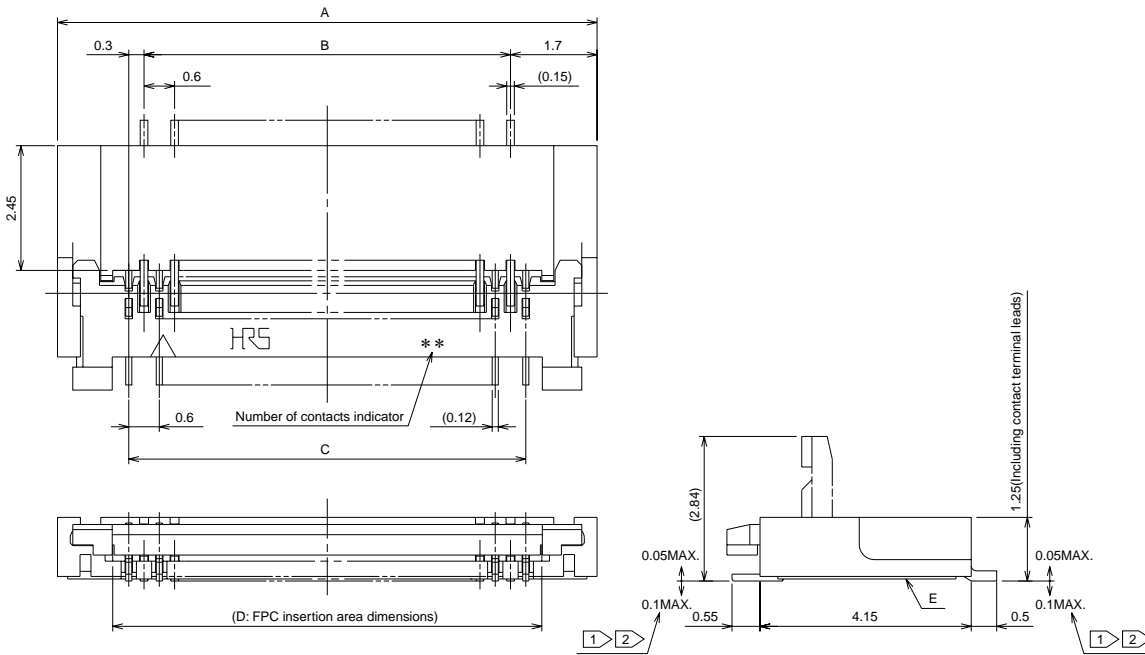

- Notes
- ① The coplanarity of each terminal lead is within 0.1.
 - ② The contact terminal lead position indicates the dimension from the E surface, the bottom surface of the insulator body.
 - ③ Any discoloration of the plastic compound will NOT AFFECT form, fit or function of the connector.

Lead Type

Unit: mm

Part Number	CL No.	Number of Contacts	A	B	C	D	RoHS
FH23-15S-0.3SHW(05)	586-1317-0-05	15	7	3.6	4.2	4.83	YES
FH23-17S-0.3SHW(05)	586-1300-7-05	17	7.6	4.2	4.8	5.43	
FH23-21S-0.3SHW(05)	586-1314-1-05	21	8.8	5.4	6	6.63	
FH23-23S-0.3SHW(05)	586-1324-5-05	23	9.4	6	6.6	7.23	
FH23-25S-0.3SHW(05)	586-1322-0-05	25	10	6.6	7.2	7.83	
FH23-27S-0.3SHW(05)	586-1308-9-05	27	10.6	7.2	7.8	8.43	
FH23-31S-0.3SHW(05)	586-1302-2-05	31	11.8	8.4	9	9.63	
FH23-33S-0.3SHW(05)	586-1304-8-05	33	12.4	9	9.6	10.23	
FH23-37S-0.3SHW(05)	586-1335-1-05	37	13.6	10.2	10.8	11.43	
FH23-39S-0.3SHW(05)	586-1306-3-05	39	14.2	10.8	11.4	12.03	
FH23-45S-0.3SHW(05)	586-1318-2-05	45	16	12.6	13.2	13.83	
FH23-51S-0.3SHW(06)	586-1312-6-06	51	17.8	14.4	15	15.63	
FH23-61S-0.3SHW(05)	586-1310-0-05	61	20.8	17.4	18	18.63	
FH23-71S-0.3SHW(05)	586-1320-4-05	71	23.8	20.4	21	21.63	

Note1: Embossed tape reel packaging(2,500 pieces/reel)

Order by number of reels.

Note2: The specification of (06) is applied to number of 51.

Refer to ordering information.

■ Connector Dimensions Diagram (Leadless Type termination)

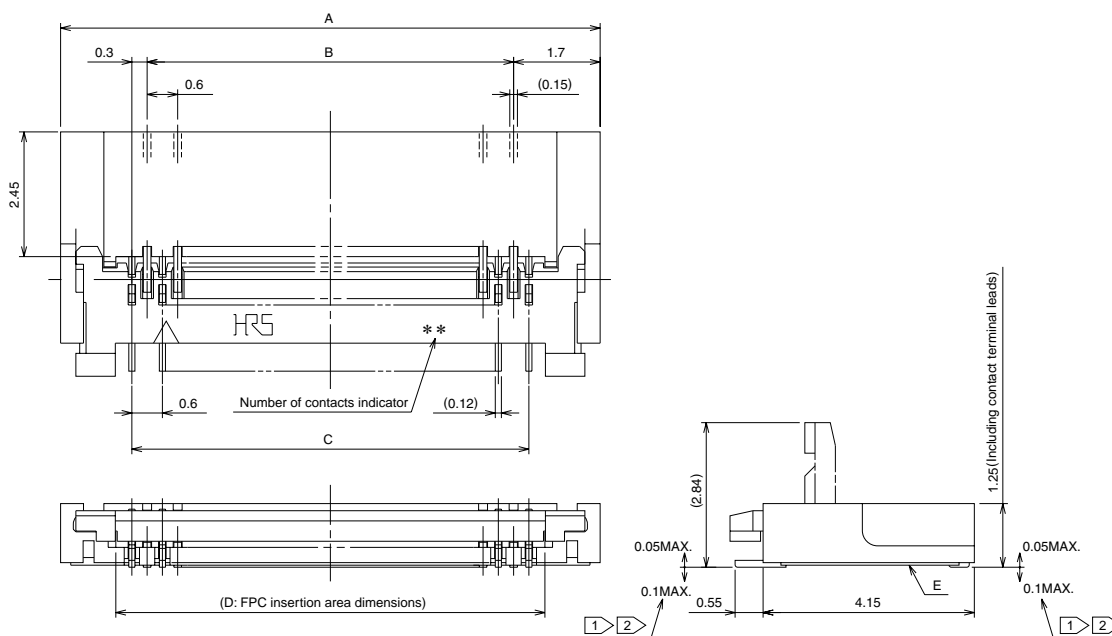

- Notes
- ① The coplanarity of each terminal lead is within 0.1.
 - ② The contact terminal lead position indicates the dimension from the E surface, the bottom surface of the insulator body.
 - ③ Any discoloration of the plastic compound will NOT AFFECT form, fit or function of the connector.

Leadless Type

Unit: mm

Part Number	CL No.	Number of Contacts	A	B	C	D	RoHS
FH23-15S-0.3SHAW(05)	586-1316-7-05	15	7	3.6	4.2	4.83	YES
FH23-17S-0.3SHAW(05)	586-1301-0-05	17	7.6	4.2	4.8	5.43	
FH23-21S-0.3SHAW(05)	586-1315-4-05	21	8.8	5.4	6	6.63	
FH23-23S-0.3SHAW(05)	586-1325-8-05	23	9.4	6	6.6	7.23	
FH23-25S-0.3SHAW(05)	586-1323-2-05	25	10	6.6	7.2	7.83	
FH23-27S-0.3SHAW(05)	586-1309-1-05	27	10.6	7.2	7.8	8.43	
FH23-31S-0.3SHAW(05)	586-1303-5-05	31	11.8	8.4	9	9.63	
FH23-33S-0.3SHAW(05)	586-1305-0-05	33	12.4	9	9.6	10.23	
FH23-37S-0.3SHAW(05)	Note3	37	13.6	10.2	10.8	11.43	
FH23-39S-0.3SHAW(05)	586-1307-6-05	39	14.2	10.8	11.4	12.03	
FH23-45S-0.3SHAW(05)	586-1319-5-05	45	16	12.6	13.2	13.83	
FH23-51S-0.3SHAW(06)	586-1313-9-06	51	17.8	14.4	15	15.63	
FH23-61S-0.3SHAW(05)	586-1311-3-05	61	20.8	17.4	18	18.63	
FH23-71S-0.3SHAW(05)	586-1321-7-05	71	23.8	20.4	21	21.63	

Note1: Embossed tape reel packaging(2,500 pieces/reel)

Order by number of reels.

Note2: The specification of (06) is applied to number of 51.

Refer to ordering information.

Note3: Reserved for future product expansion. Contact HRS for details on availability.

◆ Recommended PCB Land and Metal Mask Dimensions (Lead Type)

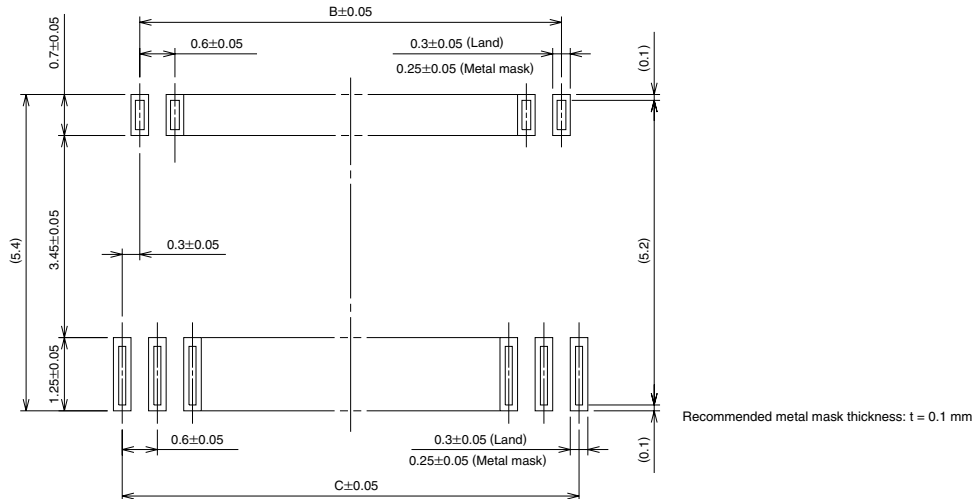

Lead Type

Unit: mm

Part Number	CL No.	Number of Contacts	B	C	G
FH23-15S-0.3SHW(05)	586-1317-0-05	15	3.6	4.2	4.8
FH23-17S-0.3SHW(05)	586-1300-7-05	17	4.2	4.8	5.4
FH23-21S-0.3SHW(05)	586-1314-1-05	21	5.4	6	6.6
FH23-23S-0.3SHW(05)	586-1324-5-05	23	6	6.6	7.2
FH23-25S-0.3SHW(05)	586-1322-0-05	25	6.6	7.2	7.8
FH23-27S-0.3SHW(05)	586-1308-9-05	27	7.2	7.8	8.4
FH23-31S-0.3SHW(05)	586-1302-2-05	31	8.4	9	9.6

Part Number	CL No.	Number of Contacts	B	C	G
FH23-33S-0.3SHW(05)	586-1304-8-05	33	9	9.6	10.2
FH23-37S-0.3SHW(05)	586-1335-1-05	37	10.2	10.8	11.4
FH23-39S-0.3SHW(05)	586-1306-3-05	39	10.8	11.4	12
FH23-45S-0.3SHW(05)	586-1318-2-05	45	12.6	13.2	13.8
FH23-51S-0.3SHW(06)	586-1312-6-06	51	14.4	15	15.6
FH23-61S-0.3SHW(05)	586-1310-0-05	61	17.4	18	18.6
FH23-71S-0.3SHW(05)	586-1320-4-05	71	20.4	21	21.6

◆ Recommended Land and Metal Mask Dimensions (Leadless Type)

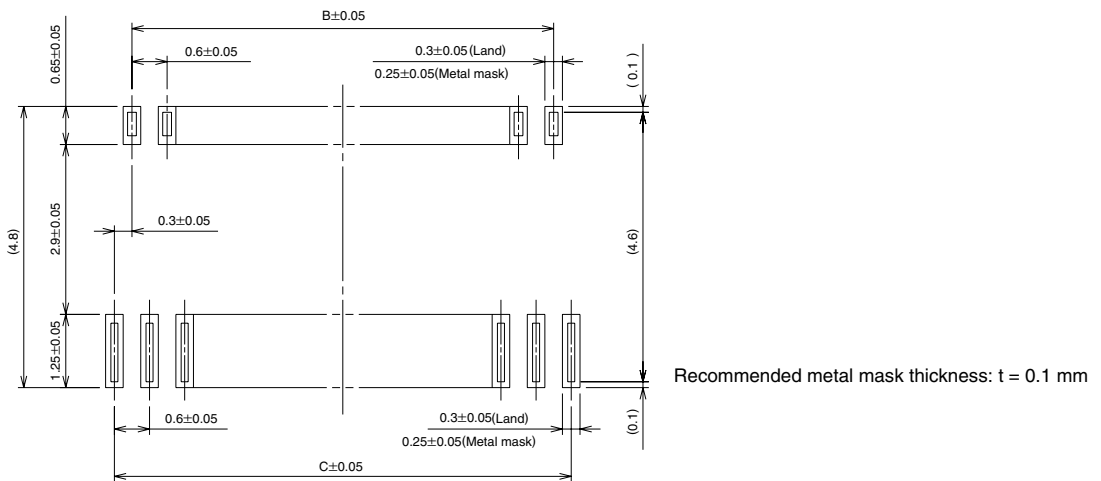

Leadless Type

Unit: mm

Part Number	CL No.	Number of Contacts	B	C	G
FH23-15S-0.3SHAW(05)	586-1316-7-05	15	3.6	4.2	4.8
FH23-17S-0.3SHAW(05)	586-1301-0-05	17	4.2	4.8	5.4
FH23-21S-0.3SHAW(05)	586-1315-4-05	21	5.4	6	6.6
FH23-23S-0.3SHAW(05)	586-1325-8-05	23	6	6.6	7.2
FH23-25S-0.3SHAW(05)	586-1323-2-05	25	6.6	7.2	7.8
FH23-27S-0.3SHAW(05)	586-1309-1-05	27	7.2	7.8	8.4
FH23-31S-0.3SHAW(05)	586-1303-5-05	31	8.4	9	9.6

Part Number	CL No.	Number of Contacts	B	C	G
FH23-33S-0.3SHAW(05)	586-1305-0-05	33	9	9.6	10.2
FH23-37S-0.3SHAW(05)	Note1	37	10.2	10.8	11.4
FH23-39S-0.3SHAW(05)	586-1307-6-05	39	10.8	11.4	12
FH23-45S-0.3SHAW(05)	586-1319-5-05	45	12.6	13.2	13.8
FH23-51S-0.3SHAW(06)	586-1313-9-06	51	14.4	15	15.6
FH23-61S-0.3SHAW(05)	586-1311-3-05	61	17.4	18	18.6
FH23-71S-0.3SHAW(05)	586-1321-7-05	71	20.4	21	21.6

Note1: Reserved for future product expansion. Contact HRS for details on availability.

● Embossed Carrier Tape Dimensions (Tape width of 32 mm min.)

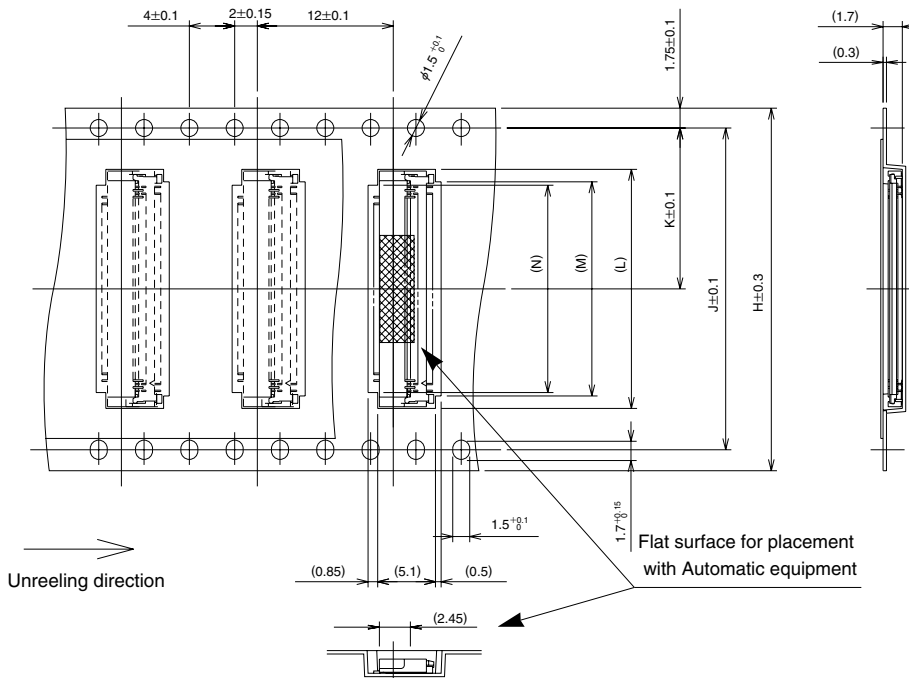

Unit: mm

Part Number	CL No.	Number of Contacts	H	J	K	L	M	N	Q	R
FH23-51S-0.3SHW(06)	586-1312-6-06	51	32	28.4	14.2	18.1	15.9	15.3	33.4	37.4
FH23-51S-0.3SHAW(06)	586-1313-9-06									
FH23-61S-0.3SHW(05)	586-1310-0-05	61	32	28.4	14.2	21.1	18.9	18.3	33.4	37.4
FH23-61S-0.3SHAW(05)	586-1311-3-05									
FH23-71S-0.3SHW(05)	586-1320-4-05	71	44	40.4	20.2	24.1	21.9	21.3	45.4	49.4
FH23-71S-0.3SHAW(05)	586-1321-7-05									

● Reel Dimensions

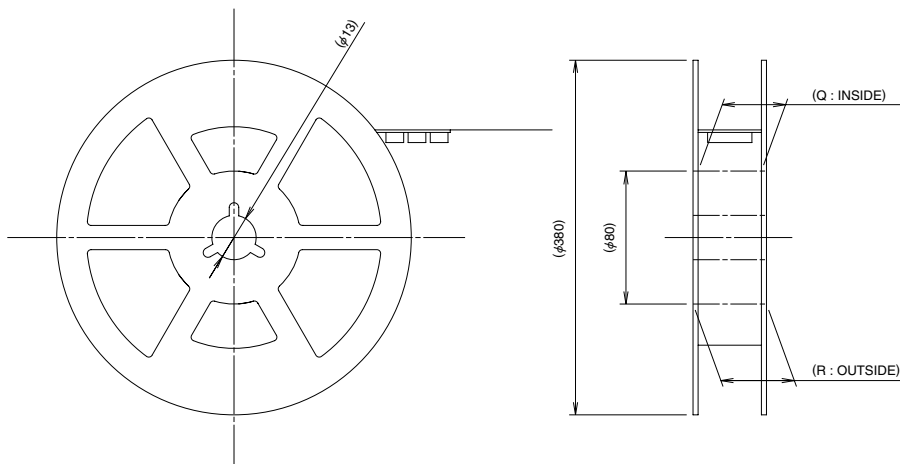

< TAPE WIDTH : 24mm MAX. >

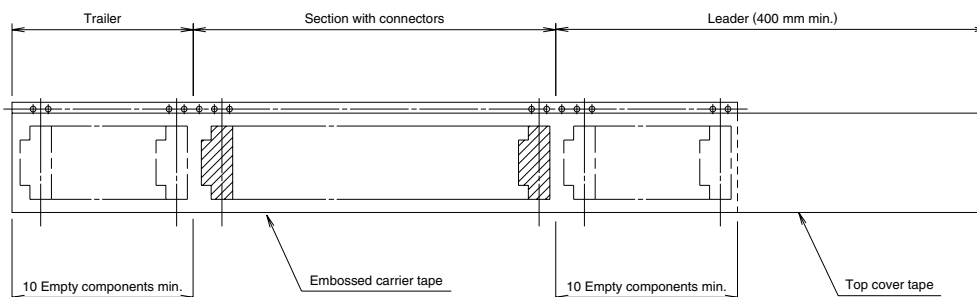

FH23 Series ● 0.5mm Contact Pitch, 1.25mm above the board, Flexible Printed Circuit Connectors

< TAPE WIDTH : 32mm MIN. >

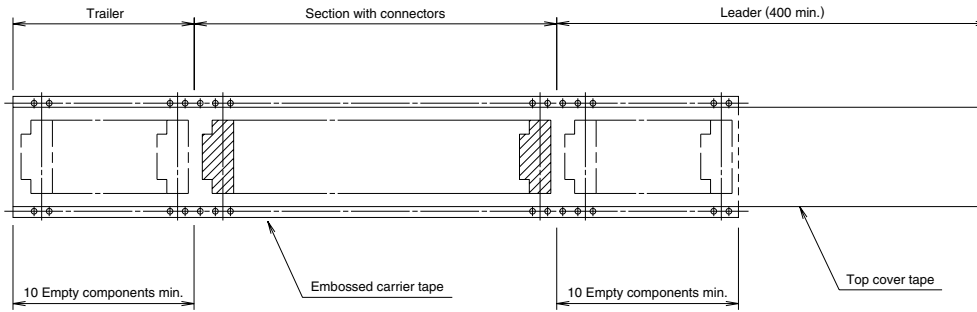

◆ **Recommended Temperature Profile**

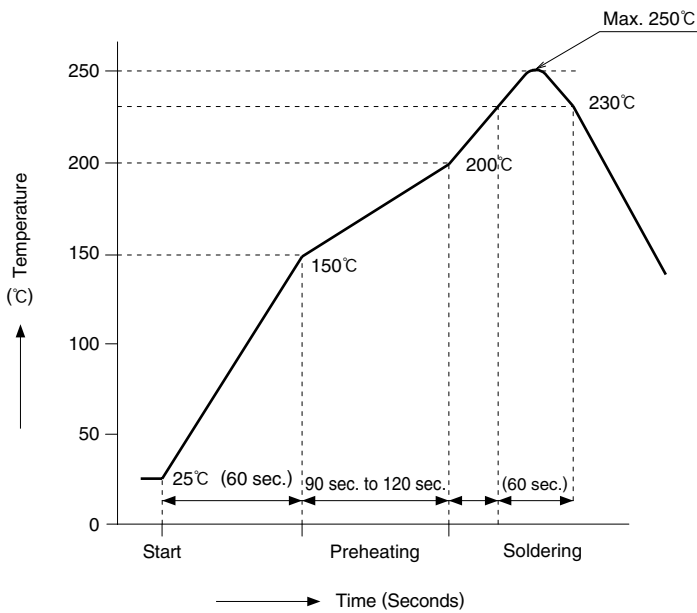

HRS test condition

- Solder method :Reflow, IR/hot air
(Nihon Den-netsu Co., Ltd.'s Part Number: SENSBY NR-II)
- Environment :Room air
- Solder composition :Paste, 96.5%Sn/3.0%Ag/0.5%Cu
(Senju Metal Industry, Co., Ltd.'s Part Number: M705-221-CM5-42-10.5)
- Test board :Glass epoxy 45mm×100mm×1.6mm thick
- Land dimensions : Lead type 0.3mm×1.25mm, 0.3mm×0.7mm
Leadless type 0.3mm×1.25mm, 0.3mm×0.65mm
- Metal mask : Lead type 0.25mm×1.25mm×0.1mm thick, 0.25mm×0.7mm×0.1mm thick
Leadless type 0.25mm×1.25mm×0.1mm thick, 0.25mm×0.65mm×0.1mm thick

In individual applications the actual temperature may vary, depending on solder paste type, volume/thickness and board size/thickness. Consult your solder paste and equipment manufacturer for specific recommendations.

◆ FH23 Series FPC Construction (Recommended Specifications)

1. Using Single-sided FPC

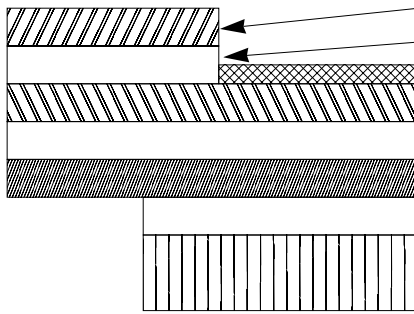

Material Name	Material	Thickness (μm)
Covering film layer.	Polyimide 1 mil thick.	25
Cover adhesive		25
Surface treatment	Nickel under plated 1 to 5μm / Gold plated 0.2μm	3
Copper foil	Cu 1oz	35
Base adhesive		25
Base film	Polyimide 1 mil thick	25
Reinforcement material adhesive	Heat-hardened adhesive	30
Stiffener	Polyimide 3 mil thick	75
Total		193

2. Using Double-sided FPC

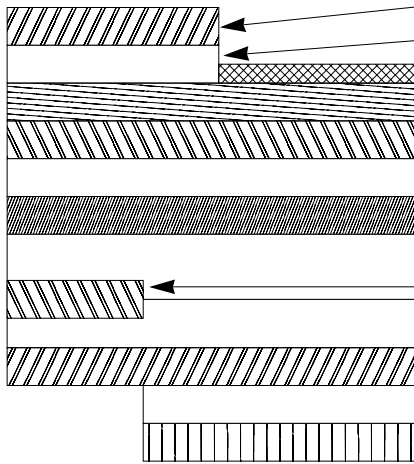

Material Name	Material	Thickness (μm)
Covering layer film	Polyimide 1 mil thick	25
Cover adhesive		25
Surface treatment	Nickel under plated 1 to 5μm / Gold plated 0.2μm	3
Through-hole copper	Cu	15
Copper foil	Cu 1/2oz	18
Base adhesive		18
Base film	Polyimide 1 mil thick	25
Base adhesive		18
Copper foil	Cu 1/2oz	18
Cover adhesive		25
Covering layer film	Polyimide 1 mil thick	25
Reinforcement material adhesive	Heat-hardened adhesive	25
Stiffener	Polyimide 1 mil thick	25
Total		197

Note : Recommended specification for FPC 0.2±0.03 mm thick.

◆ Connector Operating Instructions, precautions and recommendations

Operation

1.FPC Termination procedure. Connector installed on the board.

1) Lift up the actuator. Use thumb or index finger.

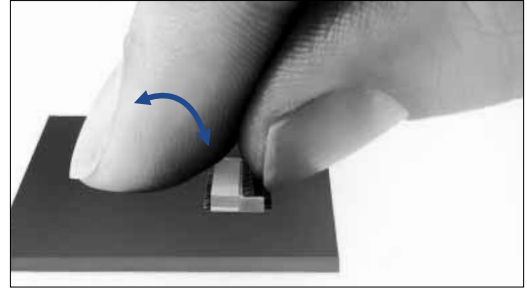

2) Fully insert the FPC in the connector parallel to mounting surface, with the exposed conductive traces facing down.

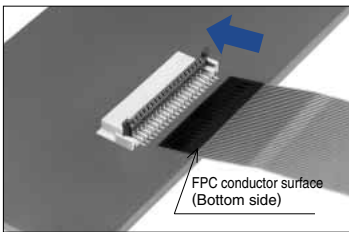

photo 1

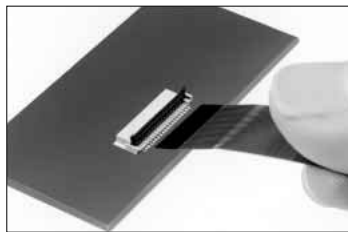

photo 2

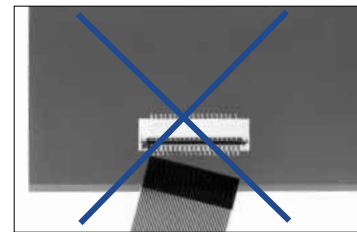
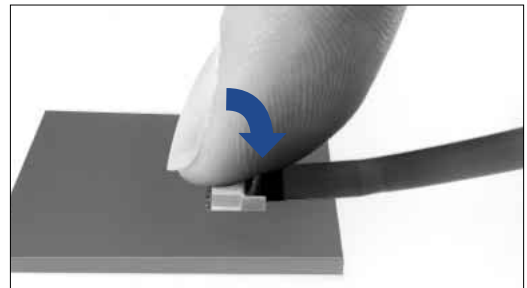
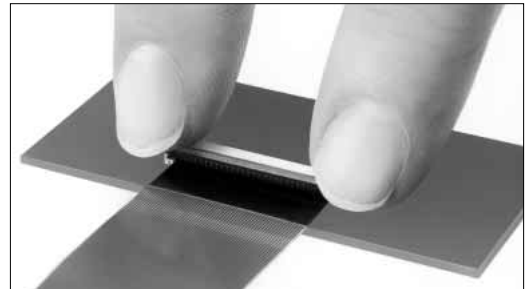

photo 3

3) Rotate down the actuator until firmly closed.
NOTE: The FPC must be fully inserted in the connector. If not fully inserted, the actuator will not close properly. Should this be the case, lift up the actuator (per Step 2 below) and repeat the process (starting with Step 1 above)



4) For connectors with multiple contacts, such as 61 and 71 pos. rotate down the actuator pushing at both ends.



2.FPC Removal

- 1) Lift up the actuator.
- 2) Carefully remove the FPC.

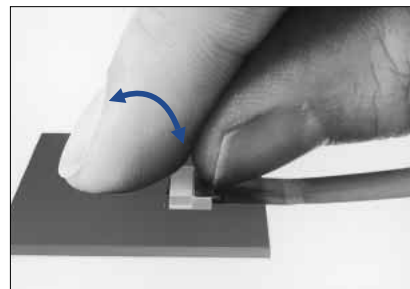

◆ Connector Operating Instructions, precautions and recommendations

Precautions

- 1) Do not apply excessive force or use any type of tool to operate the actuator.

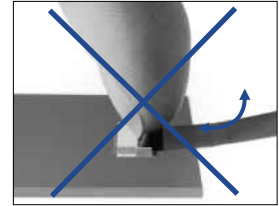
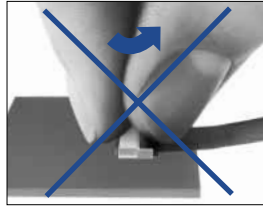

- 2) The connector will assure reliable performance when the actuator is open to 90° maximum (see fig.1) Do not exceed this angle, as this may cause permanent damage to the connector.

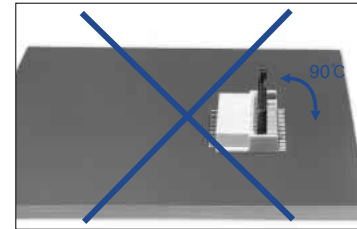

- 3) Properly insert the FPC at the positioning part of the connector. Locking the FPC while it is partially inserted, may cause lock damage, disconnection of the FPC, or continuity fault.

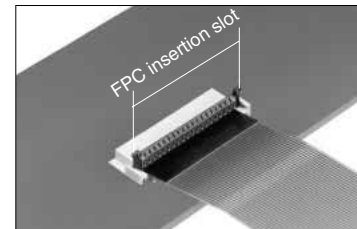

- 4) Do not apply force in the upward direction (as illustrated). Do not bend the FPC too close to the actuator.

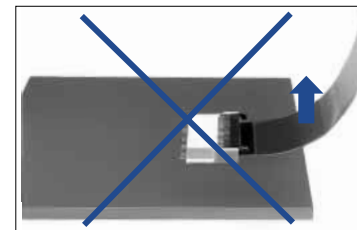

- 5) When inserting the FPC, do not forcefully rub against the bottom surface of the connector insertion entrance. Doing so will result in the contacts and FPC making strong contact and may cause deformation of the contacts, peeling of the FPC conductor, and other problems.

